

SAFARI 1D1W

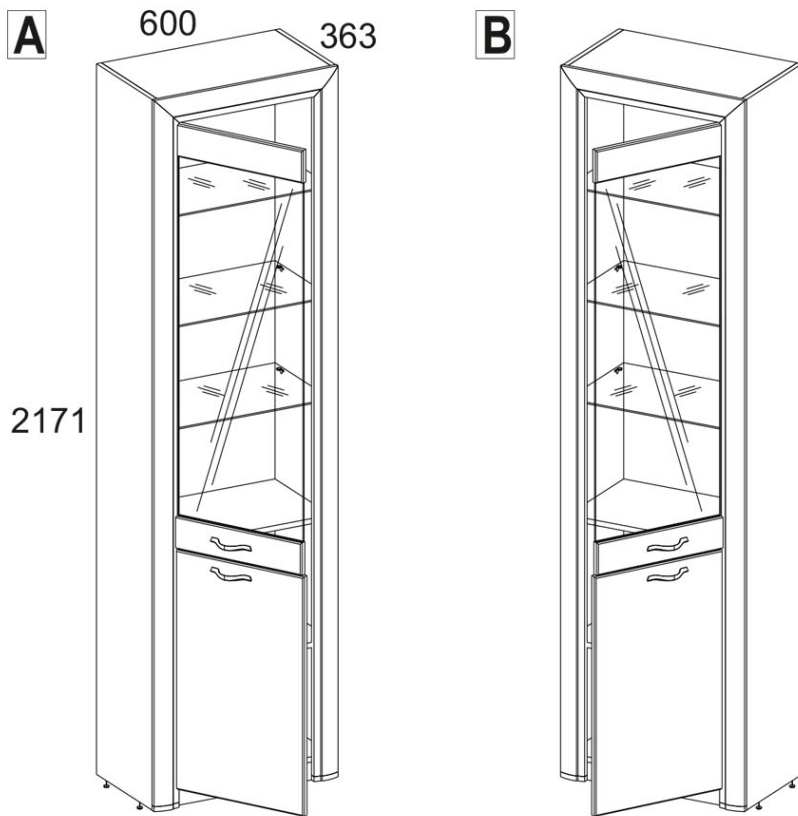

Kód	L, mm	B, mm	H, mm		balíček
1	566	335	16	1	1/4
2	566	335	16	2	1/4
3	564	335	16	1	1/4
4	564	325	6	3	1/4
6	2166	335	16	1	2/4
7	2166	335	16	1	2/4
8	2152	80	25	1	3/4
9	2152	80	25	1	3/4
10	600	80	25	1	3/4
11	1294	436	16	1	2/4
12	436	730	16	1	2/4
13	1374	592	2,5	1	4/4
14	730	592	2,5	1	4/4
25	566	55	16	1	3/4

Při používání nábytku je ZAKÁZÁNO:

- umísťovat nábytek do blízkosti topných zařízení a vlhkých zdí, taktéž do místností s relativní vlhkostí vyšší než 70 %;
- teplota ohřevu nábytkových prvků nesmí překročit + 40 °C;
- při montáži a používání nábytku stůjte nohama na vodorovných panelech a oknech;
- k čištění nábytku používat chemické čisticí prostředky;
- neměly by být vystaveny vodě.

Vůně.

Nový nábytek může vydávat vůni materiálů, ze kterých je vyroben. Vůně může přetrvávat až tři týdny po instalaci.

Pro snížení intenzity vůně se doporučuje:

- v případě čalouněného nábytku - vysajte výrobek a vyvětrejte místnost.

Opakujte 3-4x denně.

- u skříňového nábytku - otřete hadříkem navlhčeným v jemném saponátu, otřete čistým suchým hadříkem a místnost vyvětrejte, nejprve otevřete všechna dvířka a zásuvky výrobku.

Opakujte 3-4x denně. Důležité! Návod si prosím uschovejte pro případ opětovné montáže nábytku nebo reklamaci.

Při reklamaci prosím použijte označení v návodu.

VAROVÁNÍ! Pád kusu nábytku může způsobit vážná nebo smrtelná zranění v důsledku rozdrčení. VŽDY upevněte tento kus nábytku ke stěně pomocí omezovačů. Zakotvený kolík se

používá pro cihlové a betonové stěny. Pro montáž na stěnu použijte spojovací materiál vhodný pro materiál stěny, pokud si nejste jisti, jaký typ upevnění je vhodný pro daný materiál stěny, obraťte se na odborníka nebo specializovanou prodejnu.





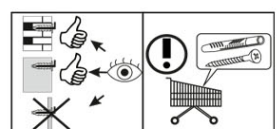
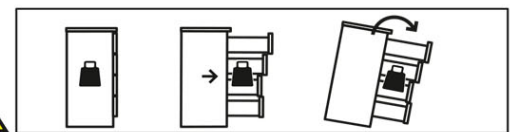

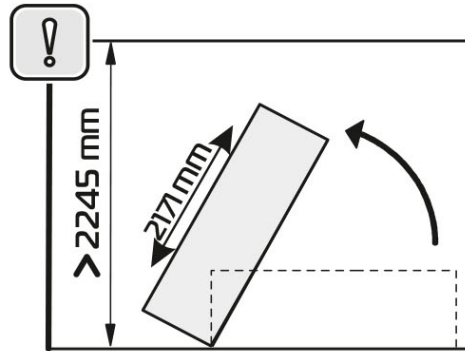
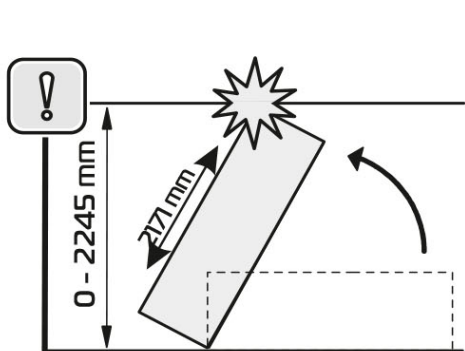
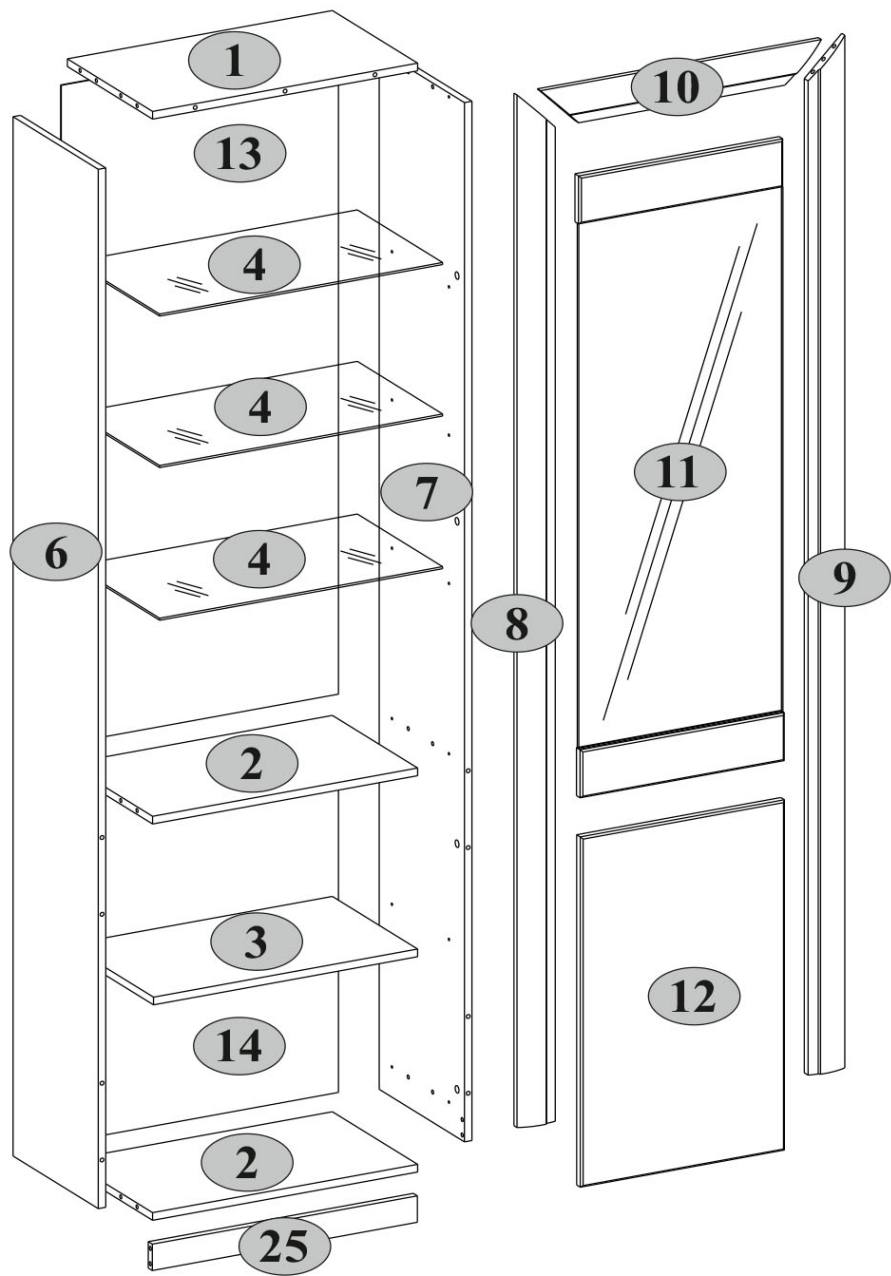

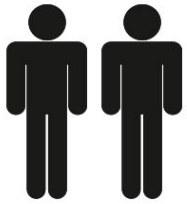



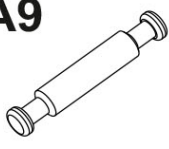

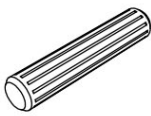
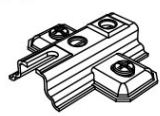
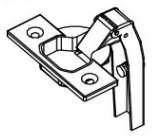

Konečnou odpovědnost za upevňovací prvky nese montér. Pro další snížení rizika vážných zranění a smrti v důsledku pádu nábytku:

- Nejtěžší předměty umístěte do spodní zásuvky.
- Nepokládejte na těžké předměty.
- Nikdy nedovolte dětem lézt na zásuvky, dvířka nebo police.
- Nábytek používejte k určenému účelu

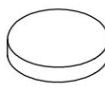



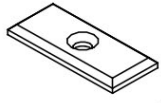

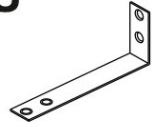
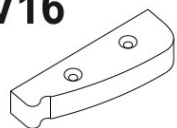

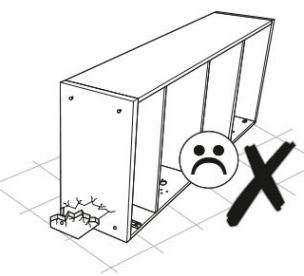
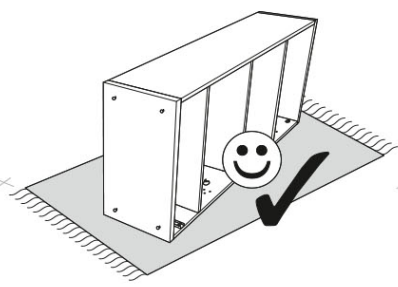
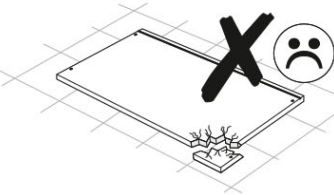
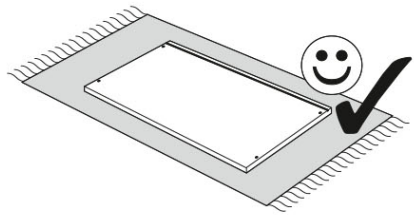
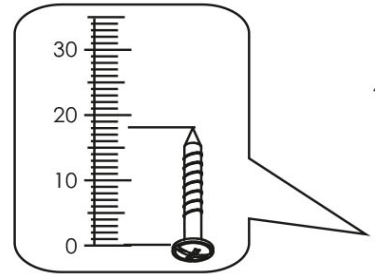
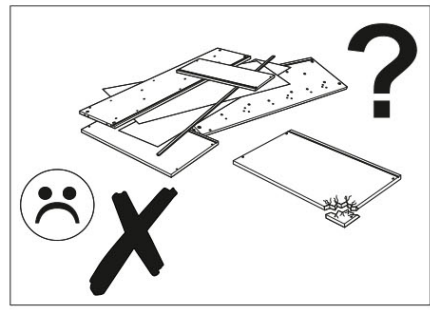
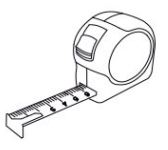
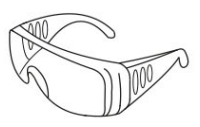
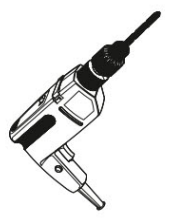
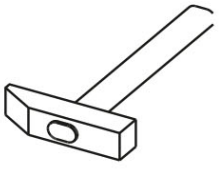
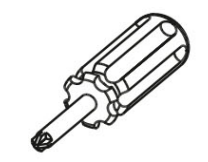
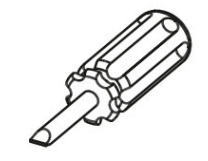
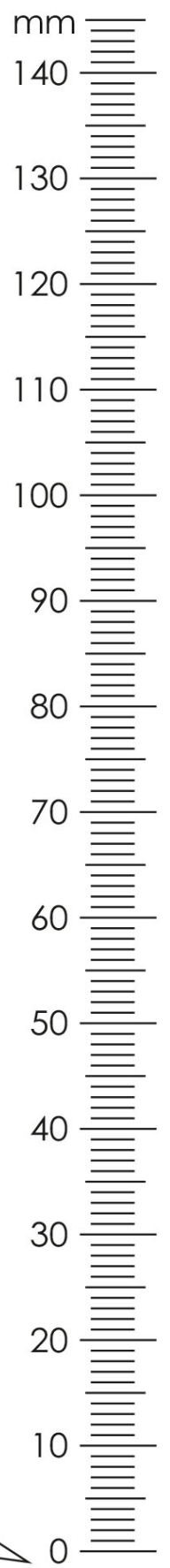

A1.0  5x28 22	A2  15x13 26	A9  L-47,4 2	B5  10x50 1
C1  8x35 29	D1  4	E2  4	G  1,5x26 36
H63  2	M4  M4x22 4	N1  4	P1  Ø5 4
P4  12	Q  1,5x7 2	R3  3x20 2	R5  3x30 4
R23  6,3x13 8	R102  3,5x16 10	S3  2	S5  Ø18 18
U  130x35x15 1		V16  80x25x15 2	



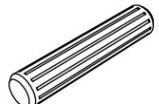

1

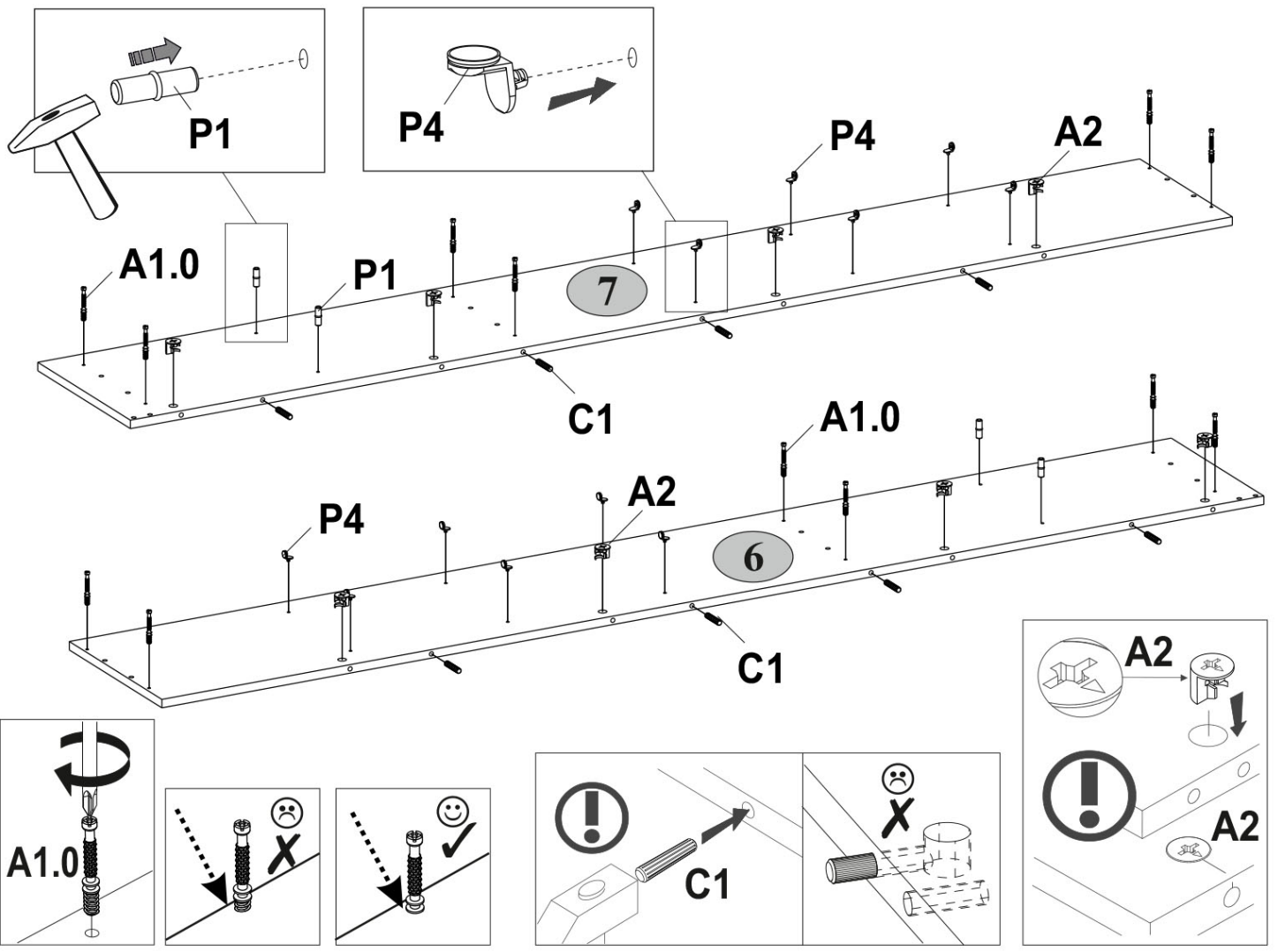
A1.0  5x28 12	A2  15x13 8	C1  8x35 8	P1  Ø5 4	P4  12
----------------------------------------------------------------------------------------------------------------	--------------------------------------------------------------------------------------------------------------	-------------------------------------------------------------------------------------------------------------	------------------------------------------------------------------------------------------------------------	--------------------------------------------------------------------------------------------------------

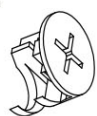

2

A2  15x13 6	C1  8x35 5
----------------------------------------------------------------------------------------------------------------	---------------------------------------------------------------------------------------------------------------

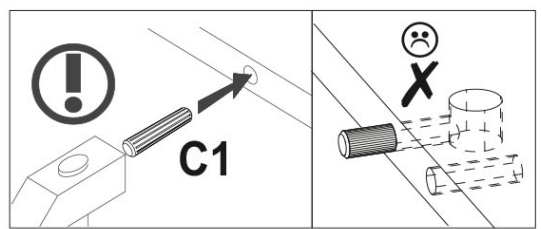
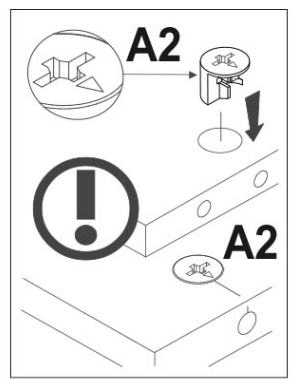
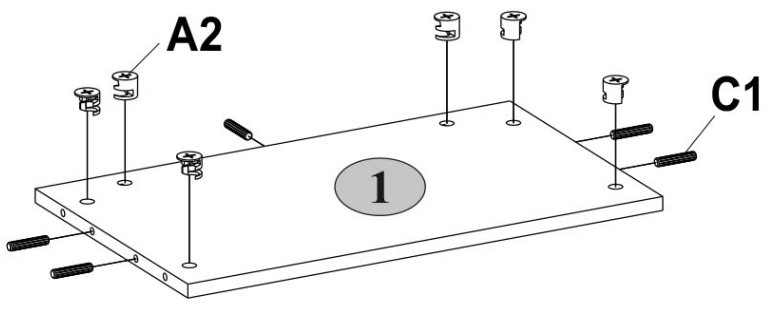

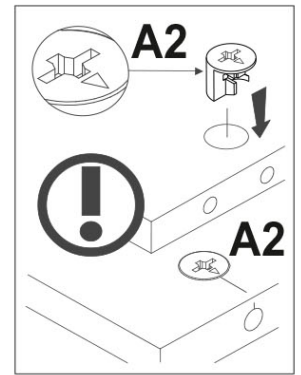
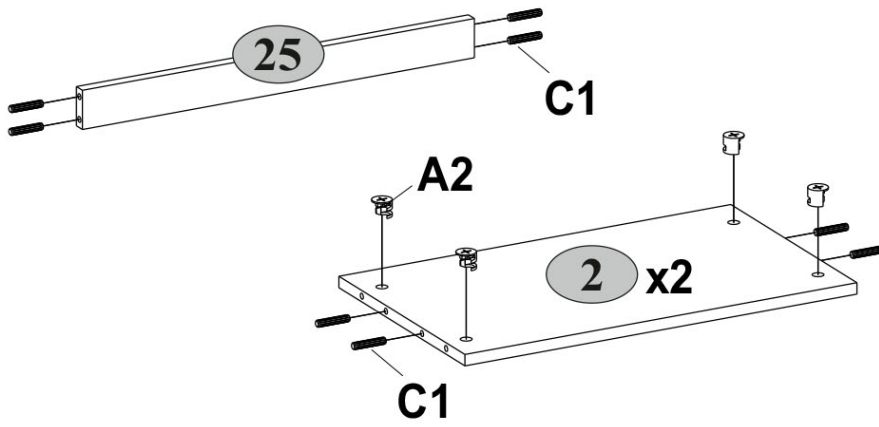
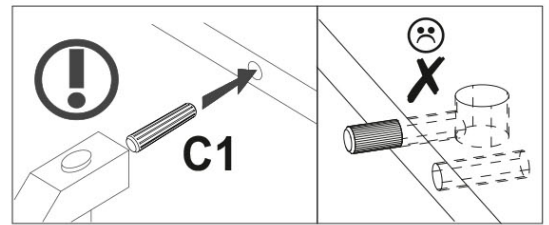
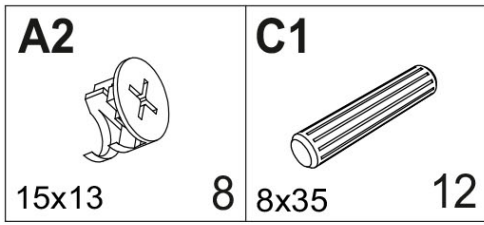

3

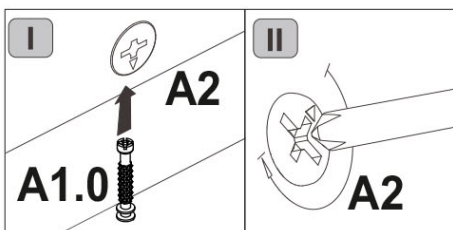
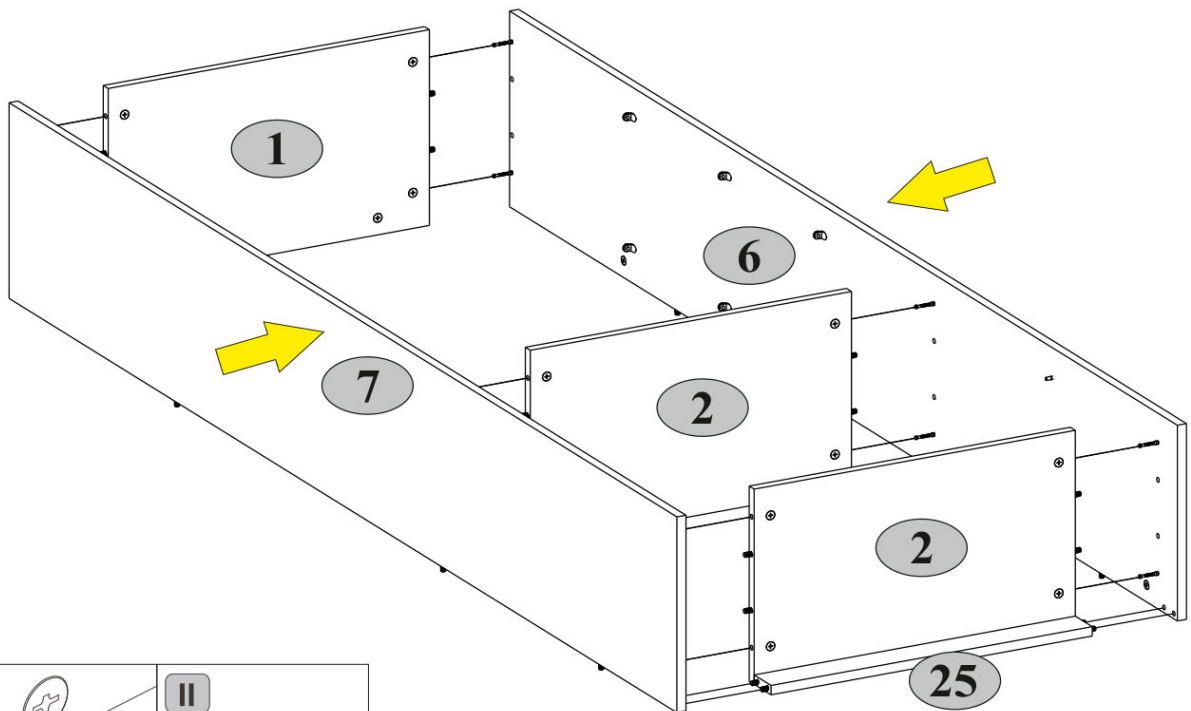

4





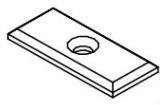

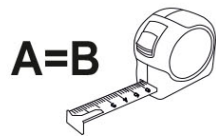
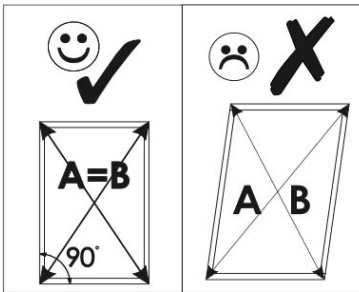
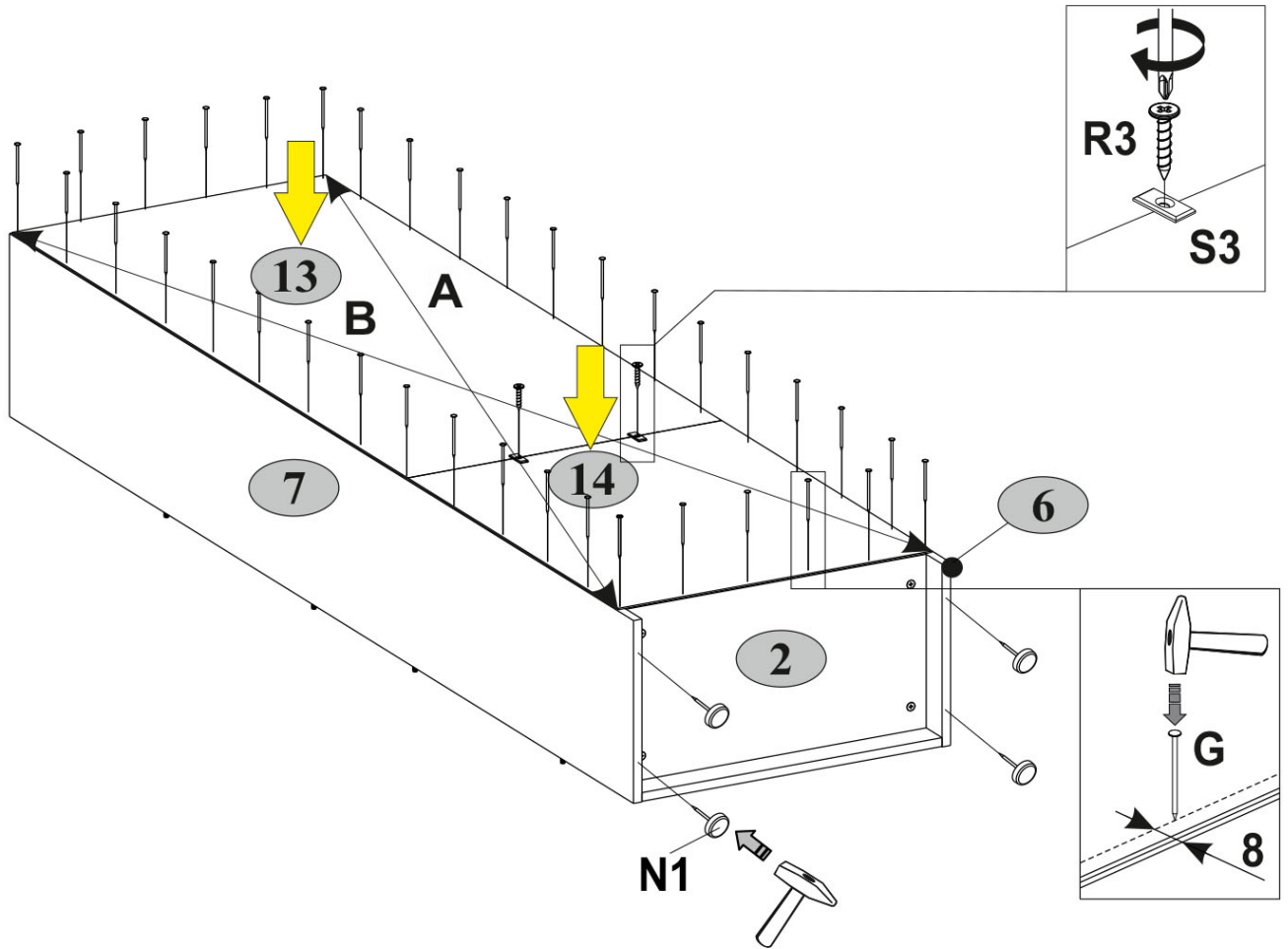
5

G  1,5x26 36	N1  4	R3  3x20 2	S3  2
---------------------------------------------------------------------------------------------------------------	-----------------------------------------------------------------------------------------------------	-------------------------------------------------------------------------------------------------------------	------------------------------------------------------------------------------------------------------

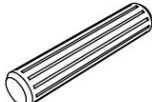

6

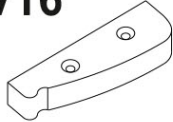

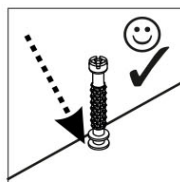
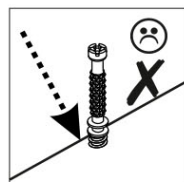
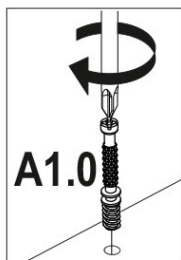
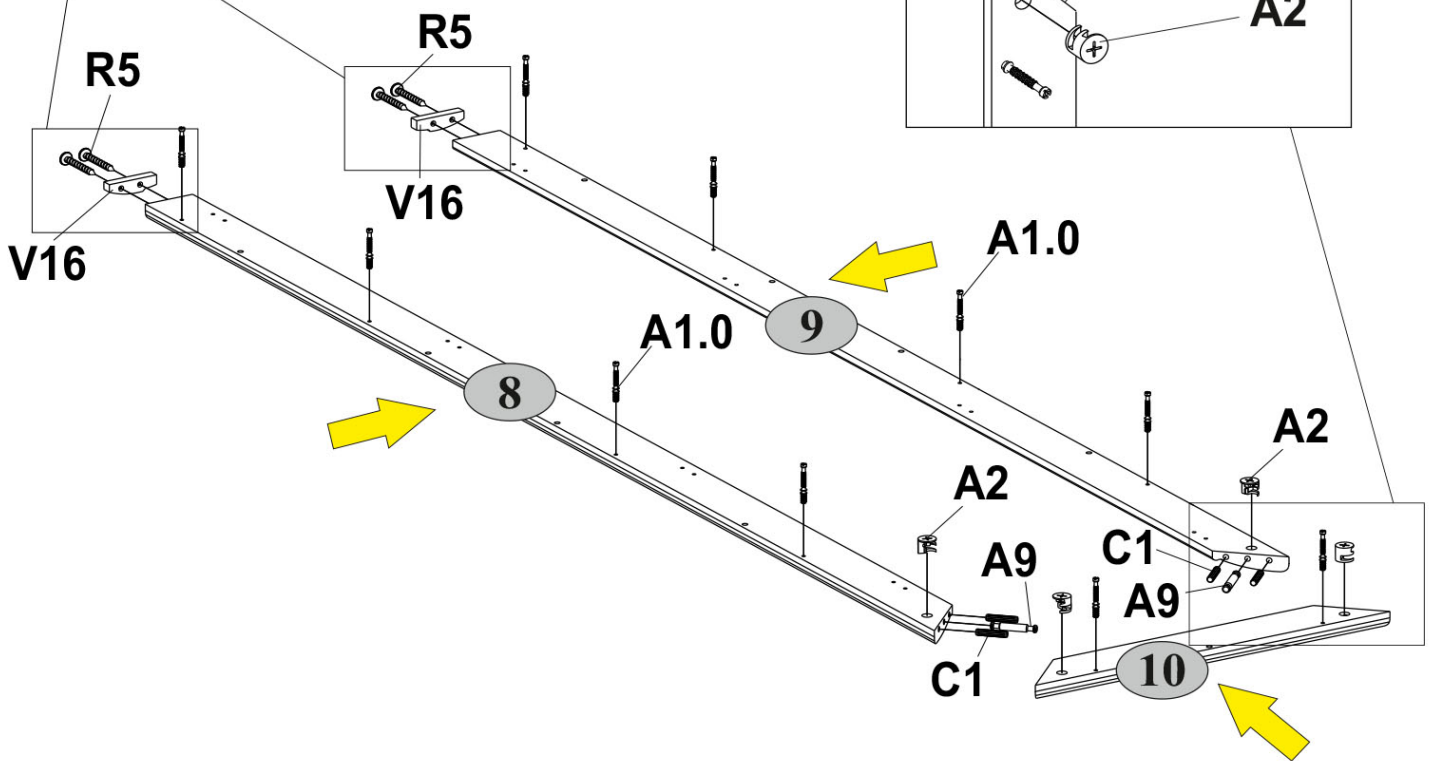
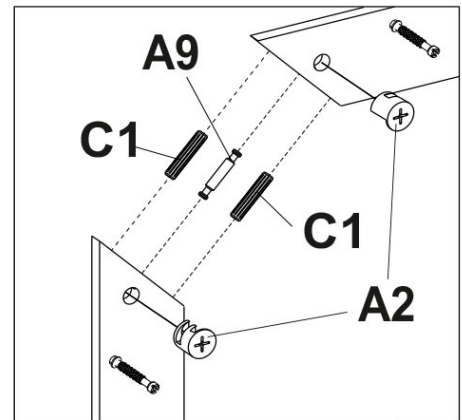
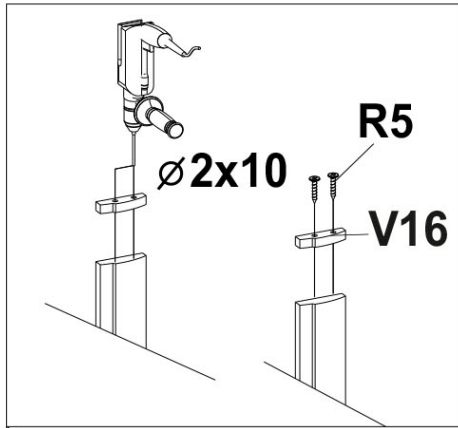

A1.0  5x28 10	A2  15x13 4	A9  L-47,4 2	C1  8x35 4	R5  3x30 4	V16  80x25x15 2
-------------------------------------------------------------------------------------------------------------	-----------------------------------------------------------------------------------------------------------	------------------------------------------------------------------------------------------------------------	-----------------------------------------------------------------------------------------------------------	------------------------------------------------------------------------------------------------------------	-----------------------------------------------------------------------------------------------------------------

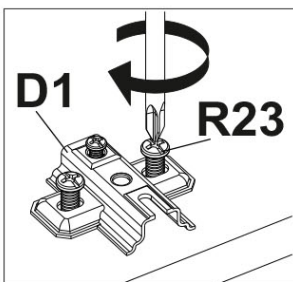
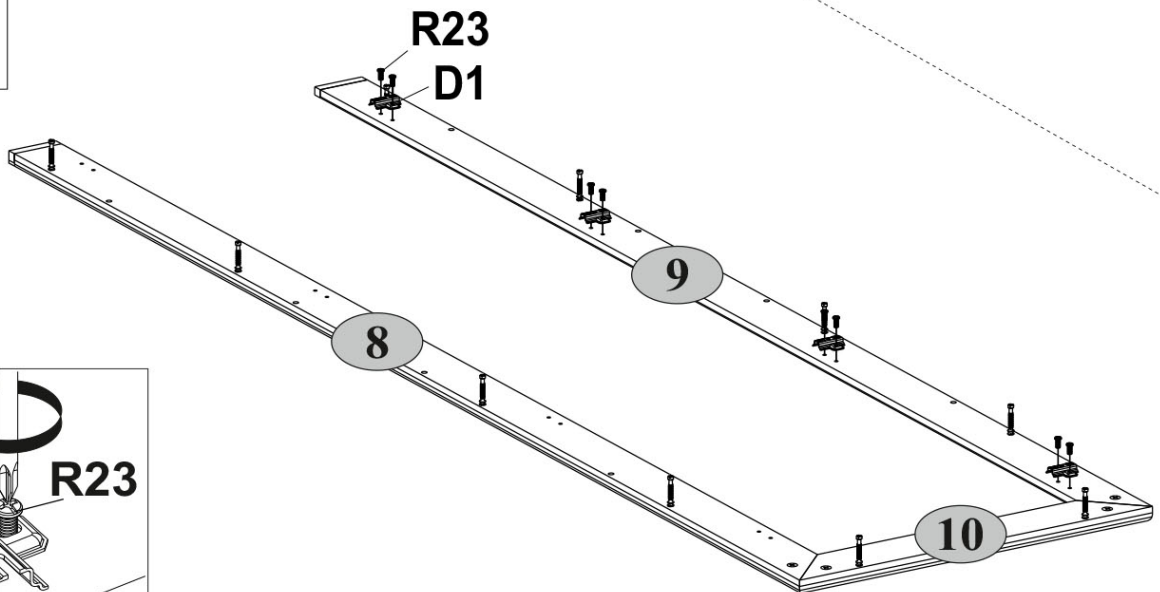
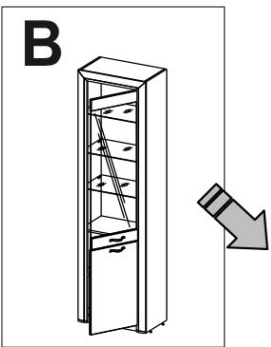
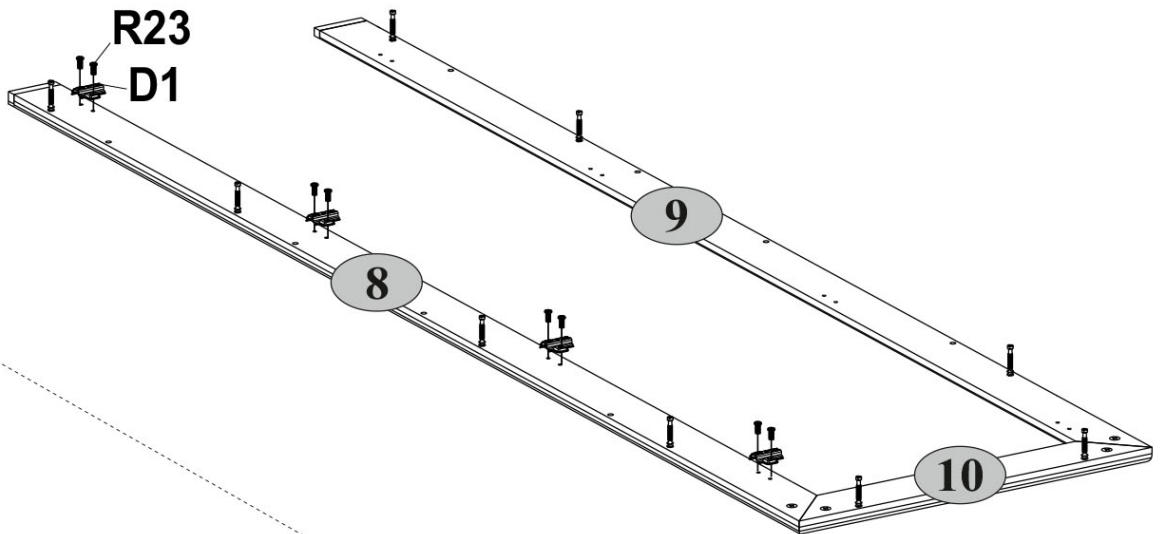
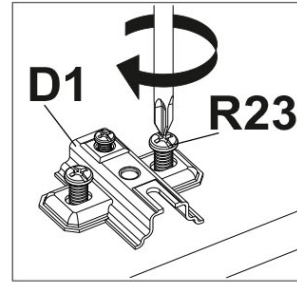
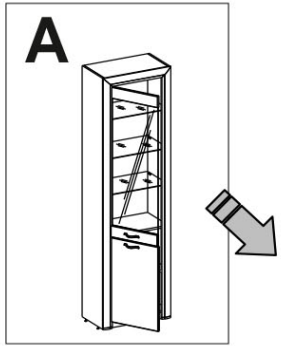
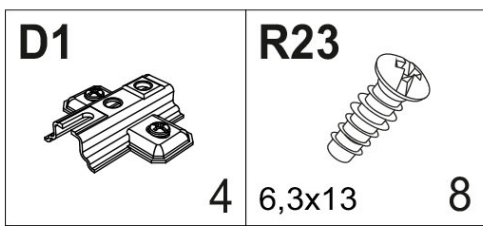

7

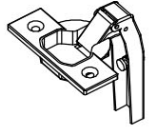

8

E2  4	H63  2	M4  M4x22 4	R102  3,5x16 8
-----------------------------------------------------------------------------------------------------	------------------------------------------------------------------------------------------------------	-----------------------------------------------------------------------------------------------------------	----------------------------------------------------------------------------------------------------------------

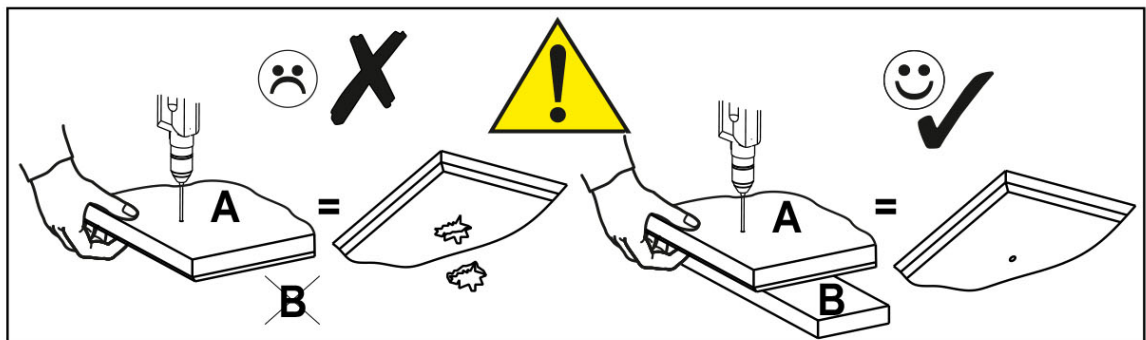
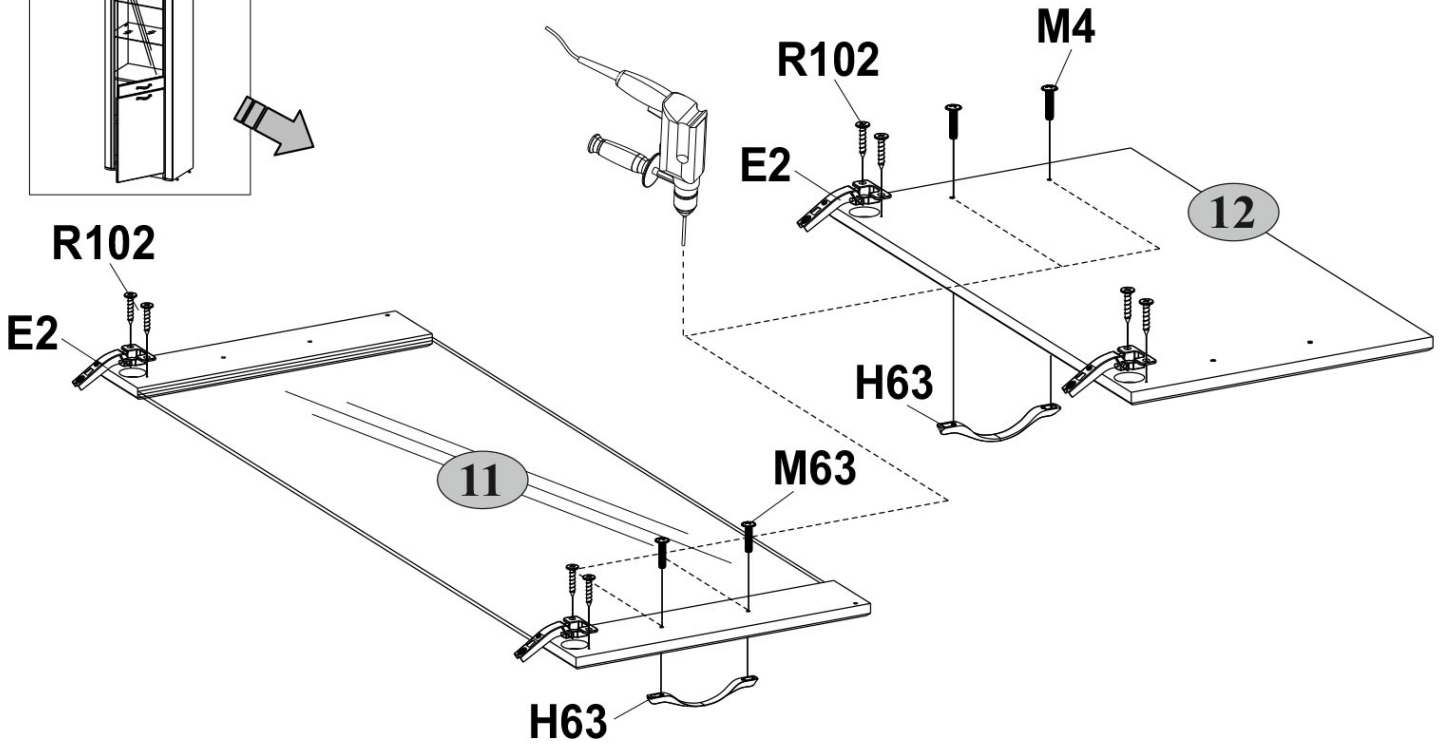
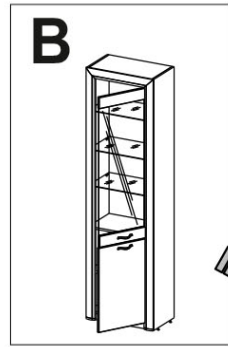
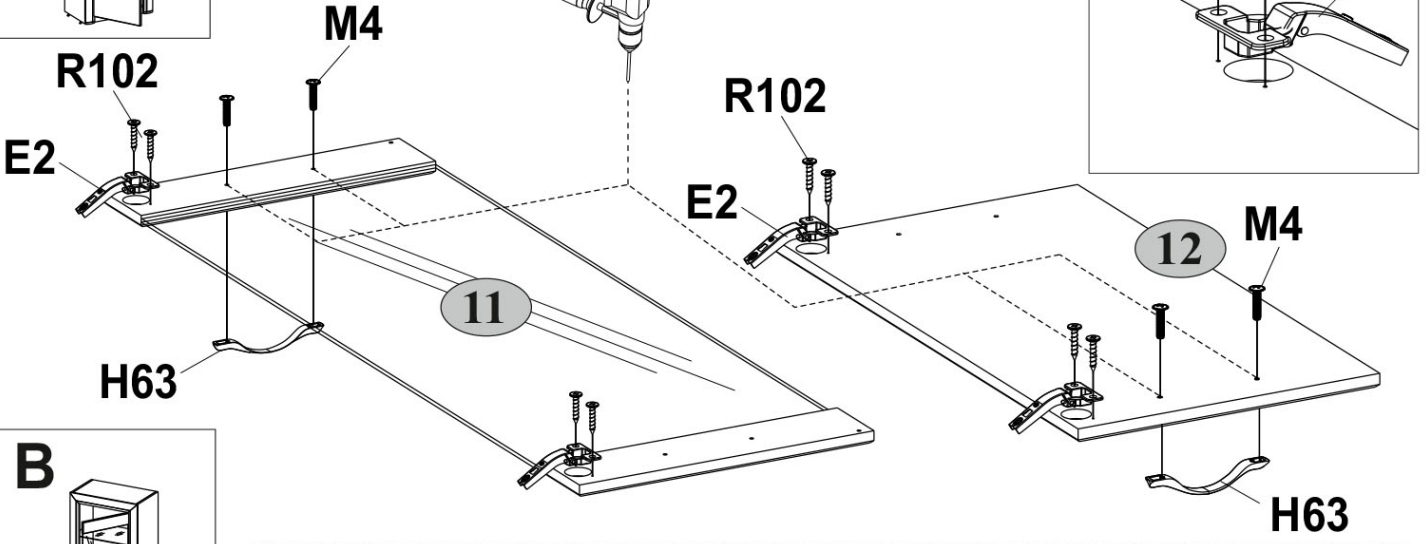
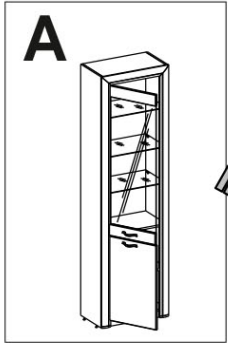

9

B5

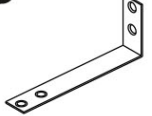
 10x50 1

U

 130x35x15 1

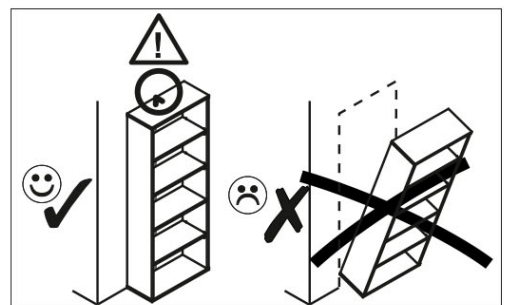
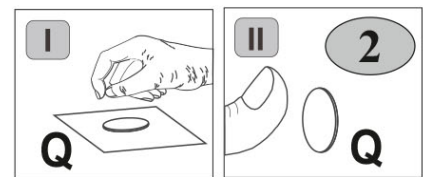
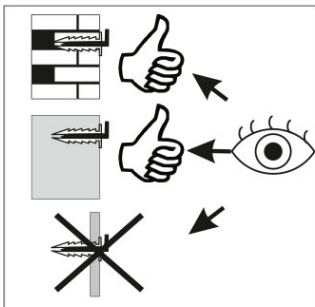
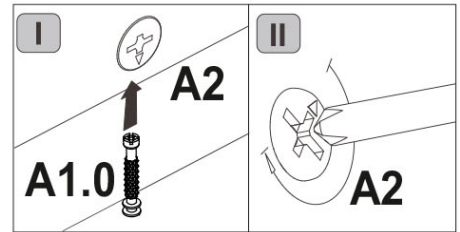
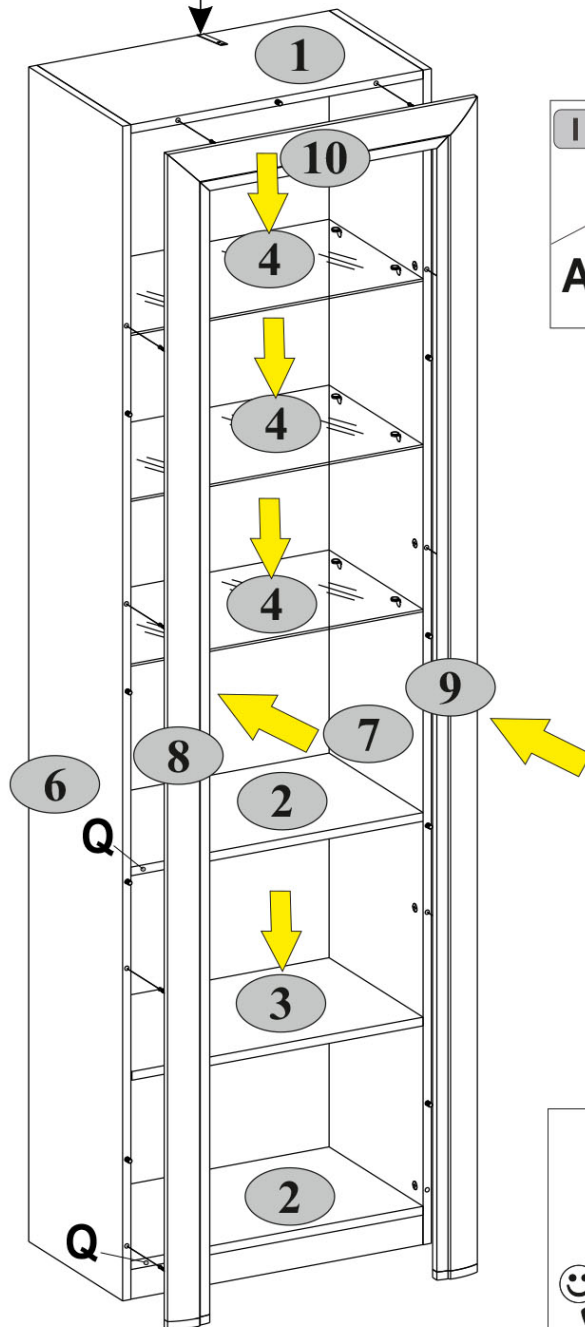
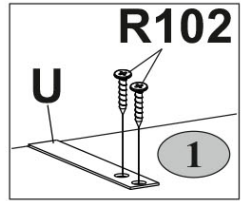
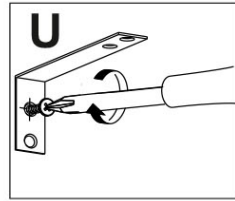
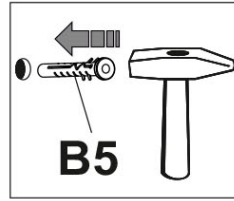
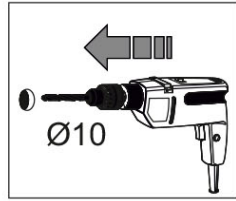
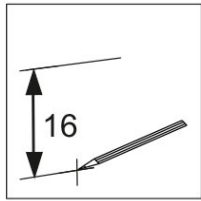
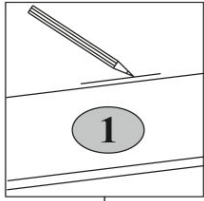
Q

 1,5x7 2

R102

 3,5x16 2

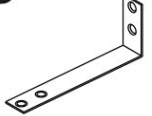

9

B5

 10x50 1

U

 130x35x15 1

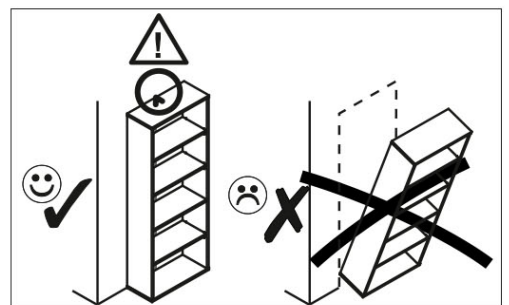
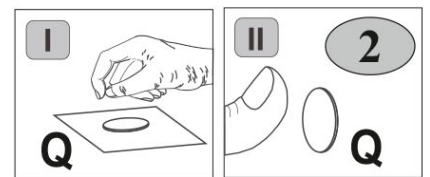
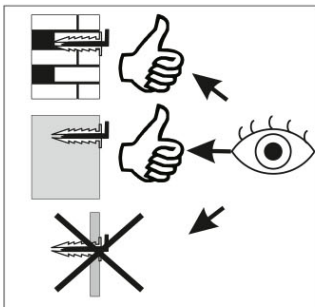
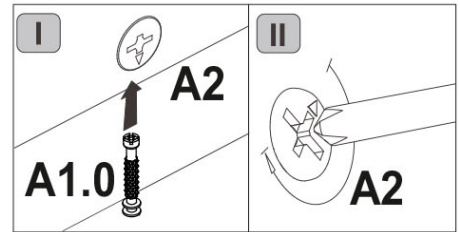
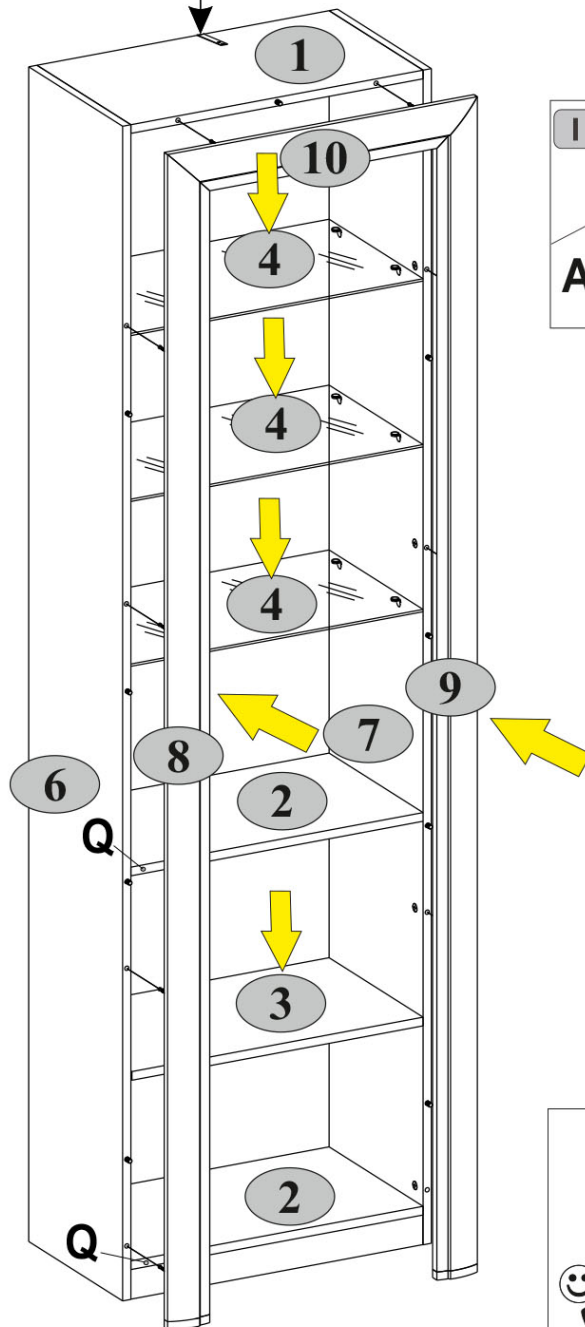
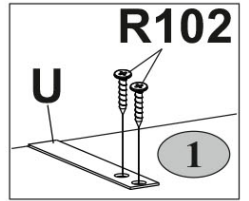
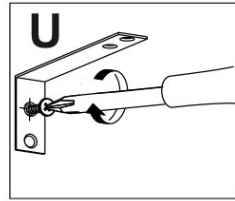
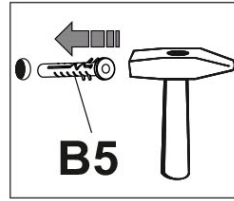
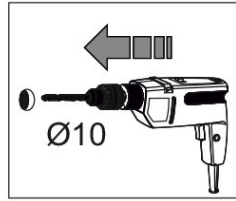
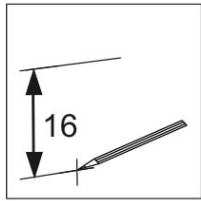
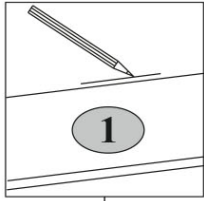
Q

 1,5x7 2

R102

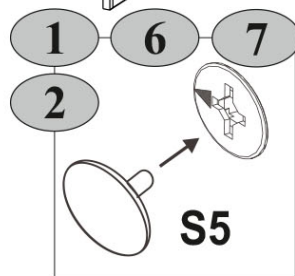
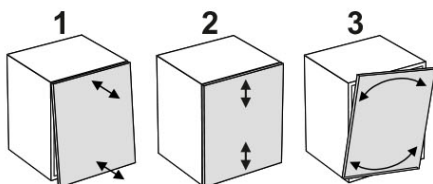
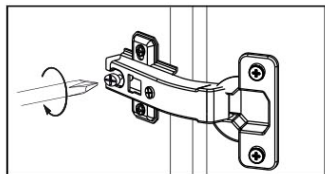
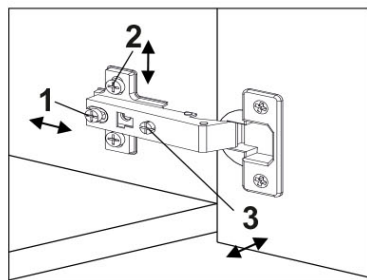
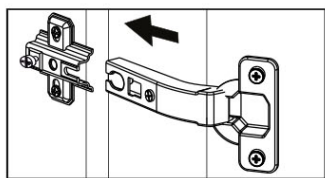
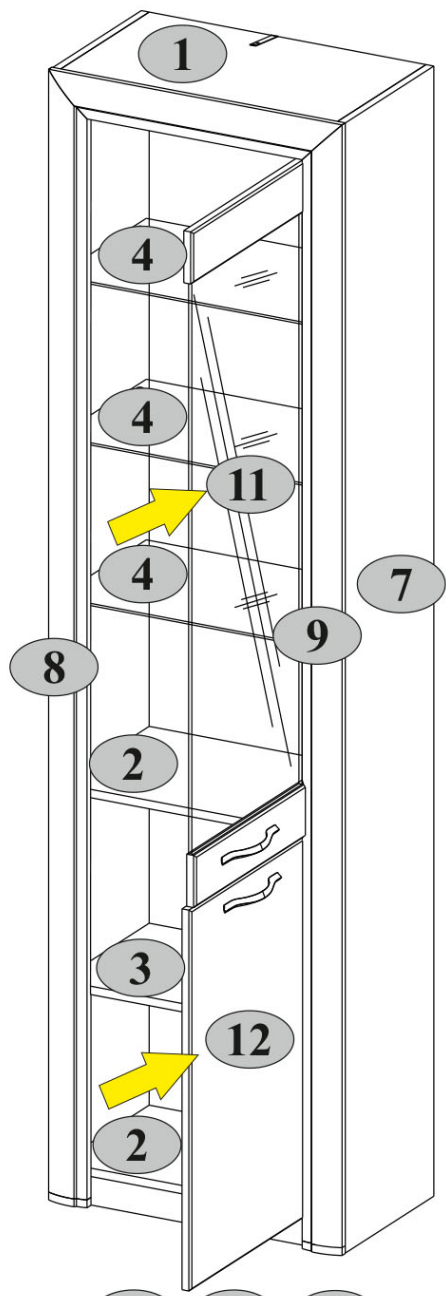
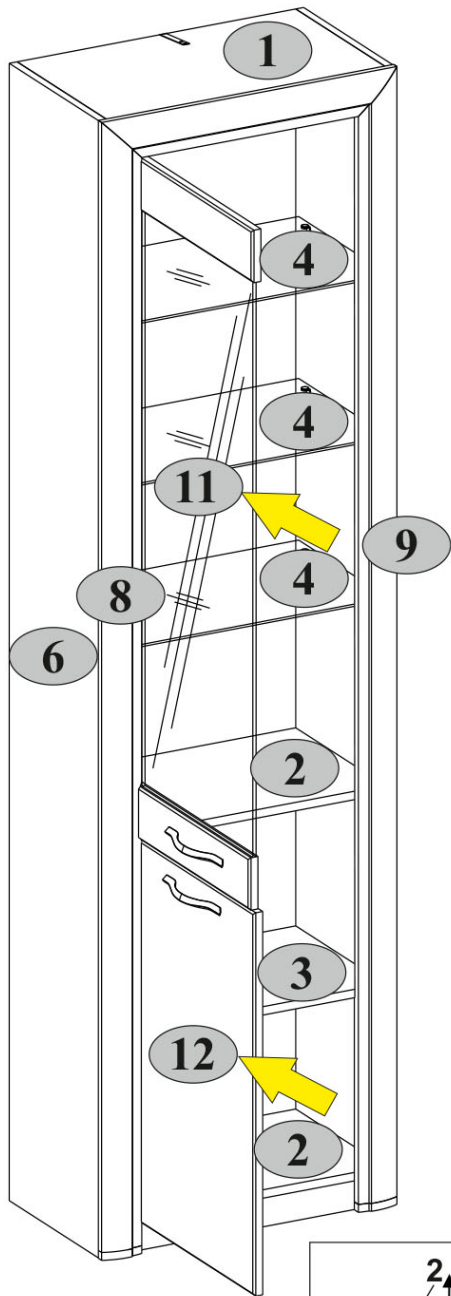
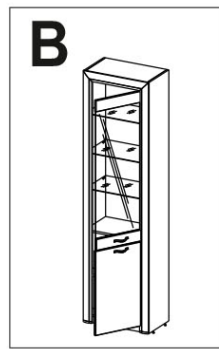
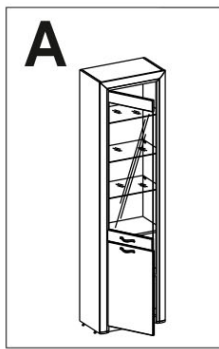
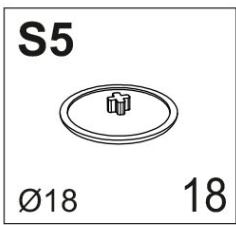
 3,5x16 2



10



 max. 5 kg